

Lamp Options:	600 x 600	2000lms	4000k
		3300lms	4000k
		4100lms	4000k
	1200 x 600	6000lms	4000k
Control Gear:	Fixed output & Dali variant electronic control gear.		
Emergency options:	3 hour maintained integral inverter Integral COMEUPS inverter (can be wired as Easy Test)		
Cable spec:	2.5mm ² Max		
Supply:	220-240V	50/60Hz	
Ingress protection:	IP54 from front		
Finish:	White (RAL 9003)		
Materials:	Mild Steel		
Fixing:	T15/T25 Exposed	- Push out tabs	
	Armstrong Orcal 1800	- Push out tabs & Recessing Panel *	
	SAS 120 ST	- Push out tabs & Recessing Panel *	
	SAS 150	- Push out tabs & Recessing Panel *	
	Cut aperture	- Lumafix brackets	
	Spring T Variants	- Lumafix brackets & Recessing Panel *	

NOTE

- * Lumafix brackets ordered as a separate item (LUMAFIXBTKIT) for prepared aperture
- * Recessing panel to be ordered separately (HRP600X600 or HRP600X1200) for spring tee ceiling

GENERAL INFORMATION

1. A qualified electrician, in accordance with IEE wiring regulations, should carry out connection to mains wiring.
2. Ensure that the rated voltage and frequency requirements are compatible with the available mains supply.
3. Cleaning of reflectors and lenses should be carried out using clean, soft and lint free cloths and anti-static cleaning fluid.
4. Do not carry out high voltage insulation test, i.e. 500/1000v this may damage internal components.
5. Electrically isolate this luminaire during maintenance.
6. Replacing the light source within this luminaire shall only be carried out by the manufacturer, service agent or a similar qualified person.

TECHNICAL SUPPORT

Tel: 0161 331 5700

e-mail: technical@whitecroftlight.com

www.whitecroftlighting.com

Whitecroft
lighting

HYGIENE LED



Installation Instructions

PART CODE: PK-HYGIENELED-LFT

SEPT 2020 – Rev B



Whitecroft Lighting Limited

Burlington Street, Ashton-under-Lyne, Lancashire OL7 0AX
Telephone +44 (0)161 330 6811

Registered No. 3848973 England

Registered Office: AS above

DIMENSIONS

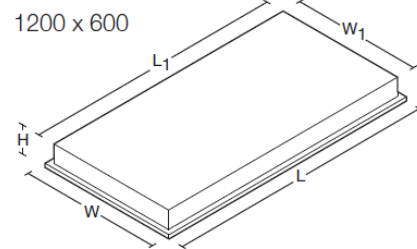
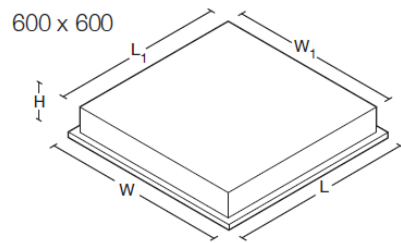

VERSION	L	W	H	L1	W1	PREPARED CUT OUT APERTURE	KG	KG EM
600 X 600	599	599	117	540	540	550 X 550	7	8
1200 X 600	1199	599	117	1140	540	550 X 1150	10	11

Installation Methodology

1. Remove luminaire assembly and accessory kit carefully from packaging.

Loosen all front frame retaining screws and remove front frame as shown. Knock out conduit holes as shown in detail A and retrieve metal discs.

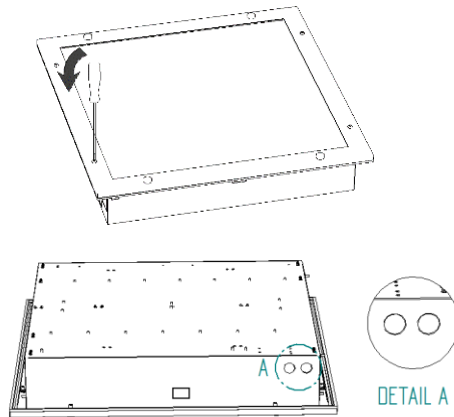

2. If fitting into **T15/T25** exposed ceiling – push-out tabs out highlighted in detail B on one side of the canopy and Proceed to step 6.

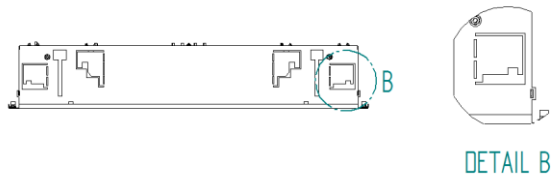

3. If fitting into **SAS 120 & Orcal 1800** push-out tabs out in detail F on one side of the canopy and Proceed to step 5. Ensure that you suspend off the highlighted area in Detail F.

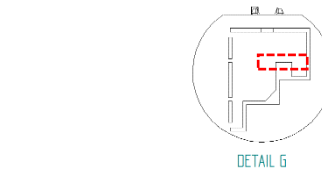
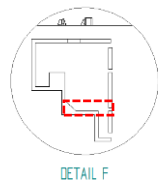

4. If fitting into **SAS 150** push-out tabs out in detail G on one side of the canopy and Proceed to step 5. Ensure that you suspend off the highlighted area in Detail G.

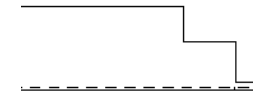

5. For all spring tee variants insert HRP600X600 recessing panel supplied separately into spring T clips.



6. Lift up into ceiling void diagonally and hook the pushed out tabs on tee bar.

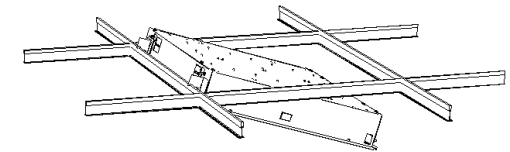

7. Drop fitting onto tee bar, locating onto tabs on all four corners as shown in detail C. Centralise the canopy pushing out the adjacent tabs as shown in detail D.

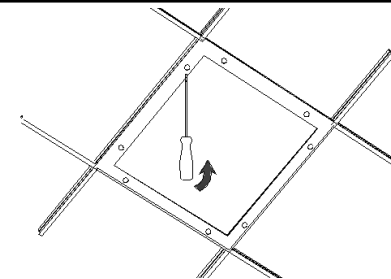
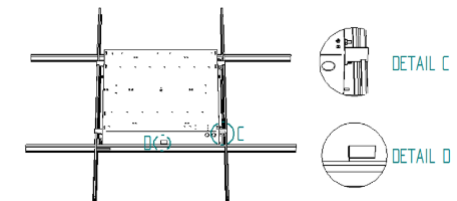

8. Feed mains cable through the knocked out conduit holes (section 1) adding restraint where applicable. Offer front frame up to fixed body. Tighten all retaining screws. Installation complete.

9. For solid ceiling, hold fitting up into ceiling. Push 4 x Lumafix brackets through slots show in detail E and pull down tight. Twist bracket assembly to lock.

